

Introduction

The DALI-I-U DALI Input Unit has 4 inputs which can be individually configured as digital inputs for a DALI control system.

Press and Release actions can be defined individually for each of the inputs through software. This enables third party control plates, sensors, door contacts etc. to be added to the iLight DALI control network.

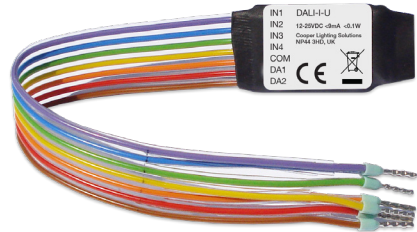

Dimensions

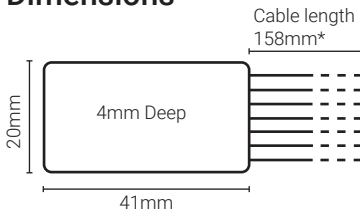

**Do not extend cables*

Installation

The unit should be installed in a dry location, where ambient temperature and humidity are within the operating limits of the unit.

If installing behind a switch, ensure the back box is sufficiently deep to accommodate the DALI-I-U so it does not get crushed as the switch plate is installed.

Control wiring

DALI-I-U includes 2 x polarity-free wires used to connect to the DALI line (0.5 mm²).

Cable colours

- Purple: Input 1
- Blue: Input 2
- Green: Input 3
- Yellow: Input 4
- Orange: COM
- Red: DALI bus
- Brown: DALI bus

Warning

This device is classified as ELV.

Third Party devices used as input devices for DALI Input Unit must have mains rating (DALI bus provides basic insulation only). Exposed conductive parts must be earthed in accordance with local wiring regulations.

Wiring Diagram

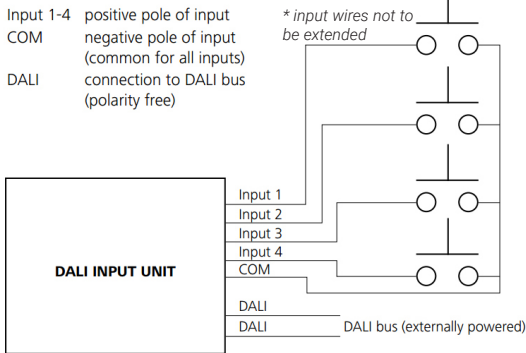

Technical Information

Power

DALI voltage: 12-25 VDC

DALI consumption: < 9mA

Control Inputs

Voltage range: Open 5VDC / closed max. 0.3VDC

Current range: Max. 1mA

Mechanical

Housing: Encapsulated PCB

Weight: 10g

Operating conditions

Ambient temp. range: 0°C - +40°C

Relative humidity: 85 % (non-condensing)

Storage temp. range: -40°C - +70°C



All products manufactured by Cooper Lighting Solutions and identified with the iLight product series mark are warranted to be free from defects in material and workmanship and shall conform to and perform in accordance with Seller's written specifications. For detailed warranty information, contact Cooper Lighting Solutions.

This warranty will be limited to the repair or replacement, at Seller's discretion, of any such goods found to be defective, upon their authorized return to Seller. This limited warranty does not apply if the goods have been damaged by accident, abuse, misuse, modification or misapplication, by damage during shipment or by improper service.

There are no warranties, which extend beyond the hereinabove-limited warranty, INCLUDING, BUT NOT LIMITED TO, THE IMPLIED WARRANTY OF MERCHANTABILITY AND THE IMPLIED WARRANTY OF FITNESS.

No employee, agent, dealer, or other person is authorised to give any warranties on behalf of the Seller or to assume for the Seller any other liability in connection with any of its goods except in writing and signed by the Seller. The Seller makes no representation that the goods comply with any present or future federal, state or local regulation or ordinance. Compliance is the Buyer's responsibility.

The use of the Seller's goods should be in accordance with the provision of the National Electrical Code, UL and/or other industry or military standards that are pertinent to the particular end use. Installation or use not in accordance with these codes and standards could be hazardous.



Cooper Lighting Solutions

Usk House, Lakeside, Llantarnam Park,

Cwmbran, NP44 3HD, UK

t: +44 (0)1923 495495 e: info@cooperlighting.co.uk

www.cooperlighting.co.uk

Document: 9850-000773-00 DALI-I-U DALI Input Unit