



## LCMD-10

Advanced Pluggable Lighting Control Solution

## LCMD-10

The iLight LCMD-10 pluggable lighting control module incorporates new technology that can dramatically reduce labour and commissioning time.

So how is this achieved?

- Automatic DALI addressing
- Connect any luminaire to any port
- Immediate 'Out of the box' functioning lighting control
- Self healing for luminaires, DALI emergencies, sensors and input devices
- Tuneable White compatible
- Conventional and DALI emergency test feature
- No Area Controller required
- Truly distributed intelligence



## Contractor / Partner

- Simple plug and play Installation, any Luminaire to any port
- Dramatic reduction in commissioning time for basic control in speculative developments
- Self addressing and self healing
- No pre-configuration required
- Pre-made tested cables means less faults on site
- Basic commissioning may be expanded to deliver exact user needs

*Less risk and less time saves money*

## Consultant / Developer / Lighting Designer

- Truly distributed intelligence provides robust and resilient control – removing single points of failure
- Extensive range of powerful user interfaces and touchscreens
- Simple and efficient integration to other building services and systems
- User-centric control and editing capabilities
- A single supplier for commercial and architectural controls and luminaires
- Extensive support documentation and application case uses
- Dedicated support through design, engineering and delivery
- Proven references and technology from a +45 years experience

*Easy to specify – plus extensive connectivity and capability*



## End User / Building Owner

- Code Compliance
- Sustainability with energy saving controls
- Flexible and extendable control solution for now and the future
- Pluggable, self healing capabilities deliver quick and easy maintenance without external contractors
- Connectivity with other building systems
- Peace of mind – one reputable supplier

*A reliable lighting control system that will be flexible and sustainable over the life of the installation*

## Any luminaire connects to any port

### Reducing installation time

Other pluggable lighting control solutions require the installer to follow a predetermined lighting installation plan, where luminaires need to be connected to prescribed ports to ensure system functionality.

The LCMD-10 removes this process as DALI luminaires, sensors and control plates can be connected to any port for basic control of the lighting system. This greatly speeds up installation time and eliminates costly installation errors.

Where front-end PC graphics are required, these are simply generated after installation as part of the commissioning.

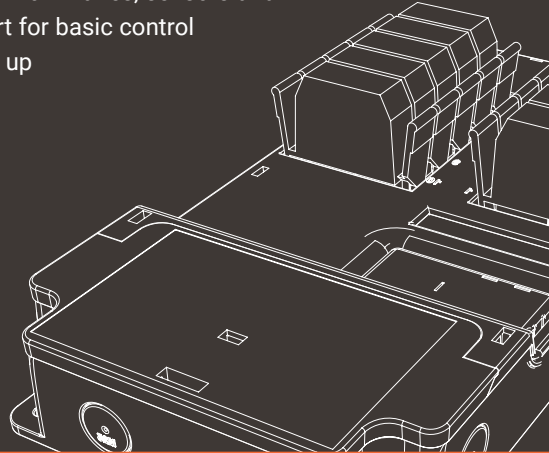

## Out the box functionality

### Speculative Office (Cat A)

The LCMD-10 is pre-configured and becomes fully operational when powered.

Prior to any commissioning or attendance from an engineer LCMD-10 will:

- Switch and dim all connected luminaires
- Automatically address all DALI luminaires, switches, control plates and sensors
- Allow a locally connected switch to provide network wide or local LCM testing (on/off, dim up/dim down)
- Allow a locally connected key switch to provide network wide or local LCM Emergency Luminaire testing
- Configure sensors for presence detection controlling all locally connected luminaires

This allows for quick and efficient testing and witnessing of the control system.

# Future Proof

## System flexibility for Tenant Fit Out (CAT B)

The LCMD-10 delivers a 'plug and play' solution where tenant's requirements and building modifications are required during fit out. If luminaires are moved or replaced they 'self heal' (DALI addressing is resolved) minimising the need for further commissioning.

LCMD-10 adds pluggable connectivity to the wider iLight control solution providing all the flexibility, features and functions expected for today's modern office environment including:

- Front End PC Graphics
- Intuitive user interfaces and touchscreens
- BMS Integration
- Audio Visual Integration
- Heating and Shading Controls



## No Need for an Area Controller

### Truly distributed intelligence

Other LCM solutions rely on a central processor (Area Controller) for the system to operate.

LCMD-10, as with all iLight products, has the intelligence built in. This eliminates the risk of a single point of failure making the system structure inherently robust providing continuity of control.

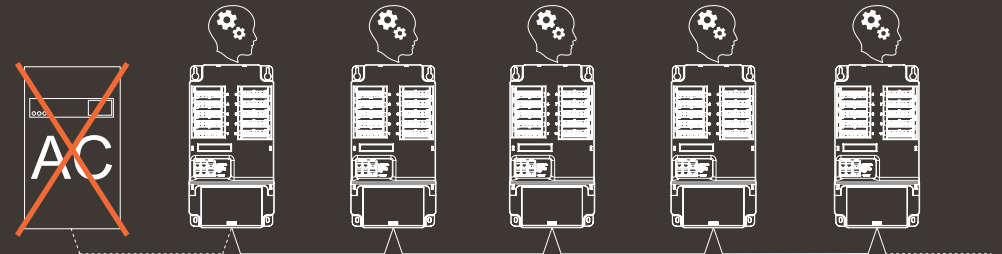

# Tuneable White

## Colour temperature and intensity adjustment

Natural daylight colour temperatures vary from warm white tones in the morning to vibrant cool white tones at midday.

The LCMD-10 is fully compatible with DT8 drivers, providing a plug and play tuneable white solution. Colour temperature adjustments can be made using scene recall, scheduled events, PIR activation or using circadian rhythm cycles giving people ultimate control of their environment.

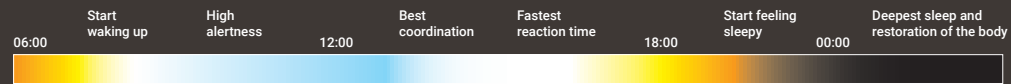

Bespoke local scene setting



Automated scene recall



Single room or building wide scene setting and adjustment

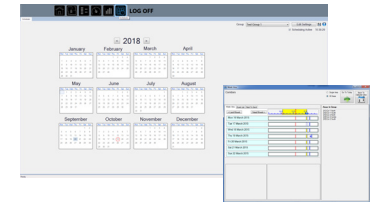

Schedules and events



# Hardware Features

- Low Profile - The height of the LCMD-10 including the plug is only 85mm which is ideal for projects where the ceiling void is limited.

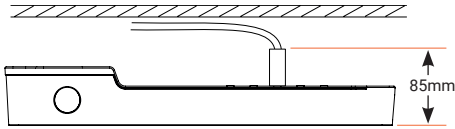

- Double latching plug & socket arrangement for secure fixing and compliance allowing local disconnection of a luminaire



- Network connection via either terminal block in the SELV wiring compartment or RJ45 sockets located on the top

- 4 x RJ12 inputs for additional input capability

- Large Wiring Compartment with mains push terminals

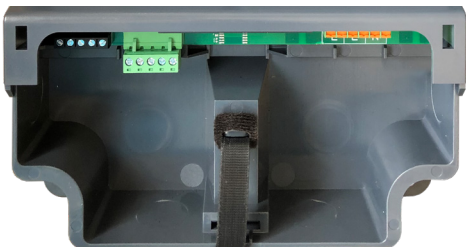

- 6 x 25mm cable entry knock outs to accommodate larger CSA cables required for LED applications



## Wiring Accessories

iLight offer a complete range of wiring accessories to simplify ordering and speed up installation. Accessories include:

- Pre-made 3, 4, 5 & 6 core luminaire leads (6 pole GST plug)
- Tee modules for daisy chaining luminaires
- Extension leads
- 6 pole BESA mounted sockets for DALI hard wired installation
- Red & black 6 pole plugs - so leads can be made up on-site

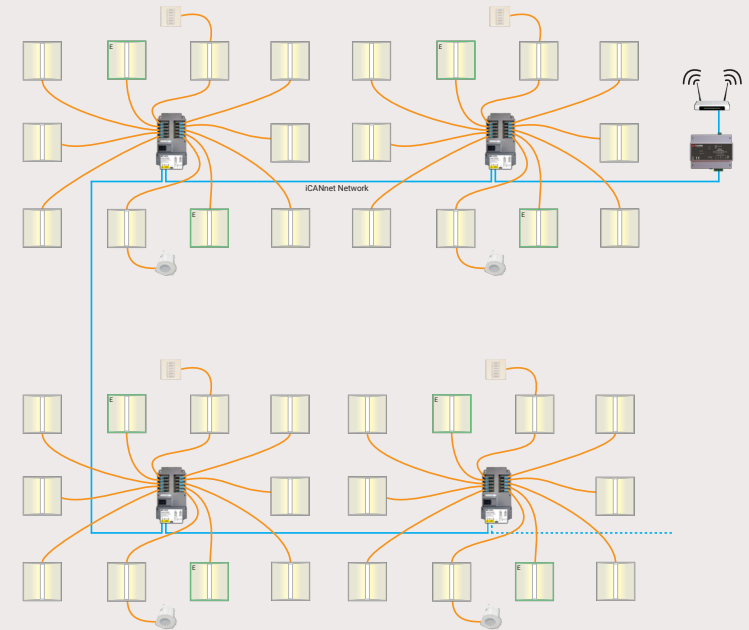

Click or scan QR code

# Specification documentation

Download everything you need to spec this product and associated system components here:



Click or scan QR code

Code	Description	Light Source	Product Code	Image	Area
CTK1	Recessed Track	LED	8610		Open Plan Office Library
CTK2	100 luminaire, recessed, 3000mm, 1000mm, 1000mm	LED	1001		Building wide control module
CTK3	100 luminaire, recessed, 3000mm, 1000mm, 1000mm	LED	1002		For building lighting in general applications
CTK4	100 luminaire, recessed, 3000mm, 1000mm, 1000mm	LED	1003		For building lighting in general applications
CTK5	100 luminaire, recessed, 3000mm, 1000mm, 1000mm	LED	1004		For building lighting in general applications
CTK6	100 luminaire, recessed, 3000mm, 1000mm, 1000mm	LED	1005		For building lighting in general applications
CTK7	100 luminaire, recessed, 3000mm, 1000mm, 1000mm	LED	1006		For building lighting in general applications
CTK8	100 luminaire, recessed, 3000mm, 1000mm, 1000mm	LED	1007		For building lighting in general applications
CTK9	100 luminaire, recessed, 3000mm, 1000mm, 1000mm	LED	1008		For building lighting in general applications
CTK10	100 luminaire, recessed, 3000mm, 1000mm, 1000mm	LED	1009		For building lighting in general applications

Lighting Control Equipment Schedules

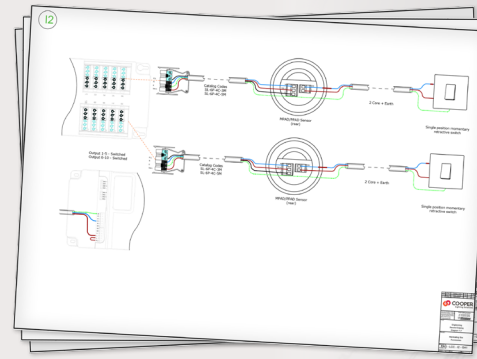

Supporting System Schematics

System Overview	System Overview
1.0. Distributed Intelligence	1.0. System Overview
2.0. Operating Principles	2.0. Operating Principles
3.0. User Interfaces	3.0. User Interfaces
4.0. Lighting Control Modules	4.0. Lighting Control Modules
5.0. System Configuration	5.0. System Configuration
6.0. Occupancy Detection	6.0. Occupancy Detection
7.0. System Integration	7.0. System Integration
8.0. Commissioning & Testing	8.0. Commissioning & Testing
9.0. Expansion	9.0. Expansion
10.0. Appendix	10.0. Appendix

System Specifications

## Related iLight literature

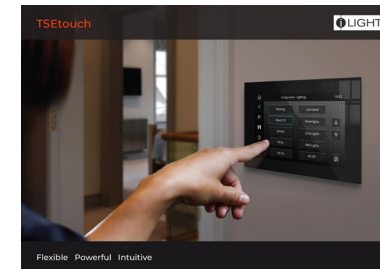
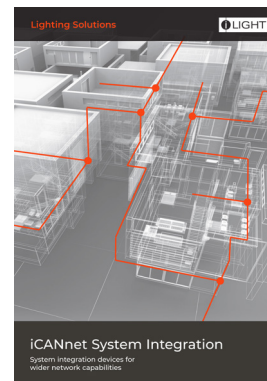
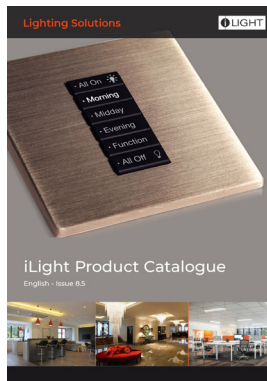

## Contact Us

+44 (0)1923 495495

enquiries@iLight.co.uk

www.iLight.co.uk

### iLight

A brand of Cooper Lighting Solutions  
Usk House, Llantarnam Park  
Cwmbran, NP44 3HD, UK

Changes to the products, to the information contained in this document, and to prices are reserved; so are errors and omissions.

© 2021 Cooper Lighting Solutions  
All Rights Reserved

iLight is a registered trademark.  
All other trademarks are property of their respective owners.

LCMD-10 Flyer Rev 6 0721



FM 664349