

SI-2-D System Integrator



Contents

Introduction	3
Dimensions	3
Environmental Data	3
iCAN Network Connections	4
Serial device connection	5
Operation indicators	4
iCANnet termination	4
Serial device connection	5
Operation indicators	5
ASCII virtual control messages	6-7

Introduction

The SI-2-D System Integrator provides a vital link point between any iCANnet network and a third party device such as an audio visual unit. The compact SI-2-D System Integrator provides a 5-way connector block at one end for the iCANnet link and a 9-pin D-type female socket at the other end for the RS232 serial connection to the third party device.

Using the intuitive Device Editor application, you can program the SI-2-D to search for particular actions or messages received from other control units attached to the iCANnet network. When a received action or message matches a stored template, the SI-2-D will send a control message to the device connected via the serial port.

Similarly, the SI-2-D also monitors messages being sent back from the connected serial device and when any of those messages match those stored within its memory, a range of actions can be triggered on the iCANnet network.

The SI-2-D System Integrator can store up to 100 input and output messages together with their related actions. Additionally, the SI-2-D can store up to 16 sequences, each of which can comprise up to 128 separate steps to allow multiple actions to be triggered by a single command.

Dimensions

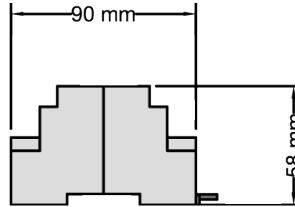

Mounting: DINrail mount with key hole slots for wall mounting if required

Environmental Data

Temperature: 0°C to +50°C
Humidity: 0 to 95% non-condensing
Rating: IP20

iCAN Network Connections

Connection to the iCAN network is made via a removable 5-way connector block located at one end of the SI-2-D unit:

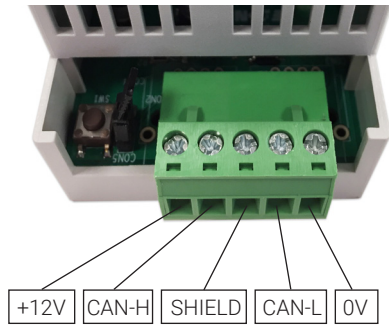

Function	Network Cable Colours
0V	Black
CAN L	White
Shield	Silver
CAN H	Blue
+12Vdc	Red

IMPORTANT NOTE: Connecting a mains potential cable to the iCAN Network terminals is likely to damage the unit and other devices connected, and invalidate warranty.

iCAN Network Identification

When pressed, the SI-2-D will send an announcement message across the iCANnet network.

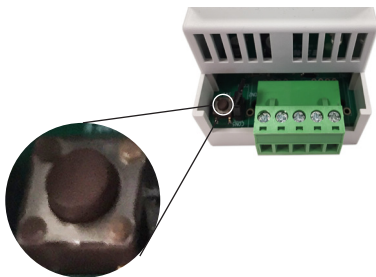

Network Termination

The iCAN network link is a 'Multi drop' linear network that requires termination on the devices located at either end of the iCAN network chain.

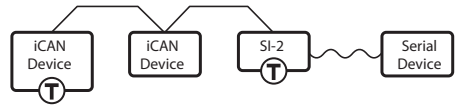

The SI-2-D unit is supplied with termination disabled as standard. If it is connected as an end device in the iCAN network, you need to move the jumper to enable termination.

The connection of the serial data cable to the device is treated separately and has no impact on whether or not the SI-2-D should be terminated on the iCAN network side. To enable SI-2-D termination, move the jumper outwards from the inner two pins to the outer two pins:

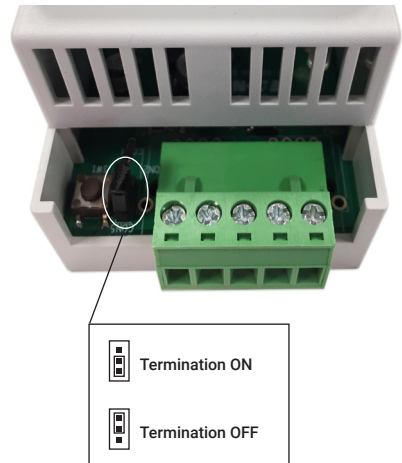

Serial device connection

The SI-2-D provides an RS232 link via a standard 9-pin D-type female connector. The SI-2-D uses five pins of the D-type connector as shown below:

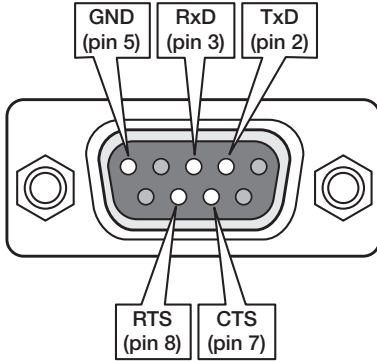

The various serial communication parameters used by the SI-2-D serial port are all fully configurable during programming.

Baud rate	1200, 2400, 4800, 9600, 19200, 38400, 57600 or 115200
Data bits	7 or 8
Stop bits	1 or 2
Parity	None, Reserved, Even or Odd
Handshaking	Enabled or Disabled

Operation indicators

The SI-2-D has a red and green LED at both the iCANnet side and the RS232 side to indicate network and communication status.

At the iCAN network end

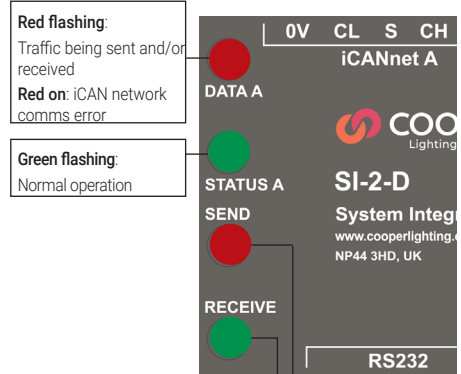

At the RS232 end

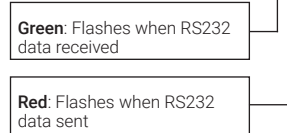

ASCII virtual control messages

In addition to translating customised commands and messages between the iCAN network and an RS232 device, the SI-2-D can convert Control Messages between the network and the connected device.

Virtual control messages are used to control the system as whole, not individual devices. These message conversions are hard coded into the SI-2-D unit and do not occupy any of the memory spaces reserved for customised commands or device level control messages. This section provides an overview of the supported virtual control messages.

The general command syntax for virtual control messages is shown here:

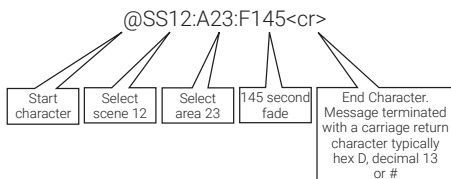

Command SS Select Scene

This message selects a scene in an area.

The syntax is: `@SSxxx:Axxx:Fxxx<cr>`

SSxxx defines the scene number, where xxx is valid from 0 to 999. Scene 0 is OFF. Axxx defines the Area Number, valid for 1 to 999. Fxxx defines the Fade Time, valid for 0 to 999 for seconds.

Command SA Save Scene

This message saves the current levels to a scene in an area.

The syntax is: `@SAxxx:Axxx<cr>`

SAxxx defines the scene number, where xxx is valid from 0 to 999 - Scene 0 saves to the current scene. Axxx defines the Area Number, valid for 0 to 999.

Command RS Request Current Scene

This message requests the current scene number in an area.

The syntax is: `@RSxxx<cr>`

RSxxx defines the Area number, valid for 1 to 999.

The response to Command RS Request Current Message will be returned in the following format:

The syntax is: `@RExxx:Axxx<cr>`

RExxx defines the Scene Number, valid for 0 to 999.

Axxx defines the Area number, valid for 1 to 999.

Command SC Set Channel (Zone) Level

This message sets the level of a channel (zone) in an area.

The syntax is: `@SCxxx:Axxx:Lxx:Fxxx<cr>`

SCxxx defines the channel (zone) number, where xxx is valid from 0 to 999. Channel 0 affects ALL channels (zones) in an area.

Axxx defines the Area Number, valid for 1 to 999.

Lxx defines the Level, valid for 0 to 99 in %, and FF for FULL (100%)

Fxxx defines the Fade Time, valid for 0 to 999 for seconds.

Command RC Request Channel (Zone) Level

This message requests the level of a channel (zone) in an area.

The syntax is: `@RCxxx:Axxx<cr>`

RCxxx defines the channel (zone) number, where xxx is valid from 0 to 999. Channel 0 requests ALL channels (zones) in an area (use with caution).

Axxx defines the Area Number, valid for 1 to 999.

The response to Command RC Request Channel (Zone) message will be returned in the following format:

The syntax is: `@RLxxx:Axxx:Lxx<cr>`

RExxx defines the Channel (Zone) Number, valid for 1 to 999.

Axxx defines the Area Number, valid for 1 to 999.

Lxx defines the Level, valid for 0 to 99 in %, and FF for FULL (100%).

Command CR Raise

This message increments the area by 1% level

The syntax is: `@CRxxx:Axxx <cr>`

CRxxx defines the channel (zone) number, where xxx is valid from 0 to 99. Channel 0 affects ALL channels (zones) in an area.

Axxx defines the Area Number, valid for 1 to 999.

Command CL Lower

This message decrements the area by 1% level

The syntax is: `@CLxxx:Axxx <cr>`

CLxxx defines the channel (zone) number, where xxx is valid from 0 to 999.

Channel 0 affects ALL channels (zones) in an area.

Axxx defines the Area Number, valid for 1 to 999.

Command SF Stop Fade

This message stops fading in an area.

The syntax is: `@SFxxx:Axxx <cr>`

SFxxx defines the channel number, where xxx is valid from 0 to 999.

Channel 0 affects ALL channels in an area.

Axxx defines the Area Number, valid for 1 to 999.

Command QS Start Sequence

This message initiates a selected sequence.

The syntax is: `@QSxx:Sxxx:Nxxx:Axxx<cr>`

QSxx defines the sequence number, where xx is 1 to 16.

Sxxx defines the segment number where xxx is 1 to 255.

Nxxx defines the node number

where xxx is 1 to 255.

Axxx defines the action (step) number where xxx is 0 to 128.

Command QP Pause Sequence

This message pauses a selected sequence.

The syntax is: `@QPxx:Sxxx:Nxxx<cr>`

QPxx defines the sequence number, where xx is 1 to 16.

Sxxx defines the segment number where xxx is 1 to 255.

Nxxx defines the node number where xxx is 1 to 255.

Command QT Stop Sequence

This message halts a selected sequence.

The syntax is: `@QTxx:Sxxx:Nxxx<cr>`

QTxx defines the sequence number, where xx is 1 to 16.

Sxxx defines the segment number where xxx is 1 to 255.

Nxxx defines the node number where xxx is 1 to 255.

Command AL Alarm Mode

This message sets or clears alarm mode for an area.

The syntax is: `@ALx:Axxx<cr>`

ALx defines either the set alarm or clear alarm mode, where 0 is clear alarm and 1 is set alarm.

Axxx defines the Area Number, valid for 0 to 999

iLight Technical Support

Tel: +44 (0)844 324 9100 (available Mon-Fri 9am-5pm GMT)

Email: cctechsupport@cooperlighting.com

Web: www.iLight.co.uk

All products manufactured by Cooper Lighting Solutions and identified with the iLight product series mark are warranted to be free from defects in material and workmanship and shall conform to and perform in accordance with Seller's written specifications. For detailed warranty information, contact Cooper Lighting Solutions.

This warranty will be limited to the repair or replacement, at Seller's discretion, of any such goods found to be defective, upon their authorized return to Seller. This limited warranty does not apply if the goods have been damaged by accident, abuse, misuse, modification or misapplication, by damage during shipment or by improper service.

There are no warranties, which extend beyond the hereinabove-limited warranty, INCLUDING, BUT NOT LIMITED TO, THE IMPLIED WARRANTY OF MERCHANTABILITY AND THE IMPLIED WARRANTY OF FITNESS.

No employee, agent, dealer, or other person is authorised to give any warranties on behalf of the Seller or to assume for the Seller any other liability in connection with any of its goods except in writing and signed by the Seller. The Seller makes no representation that the goods comply with any present or future federal, state or local regulation or ordinance. Compliance is the Buyer's responsibility.

The use of the Seller's goods should be in accordance with the provision of the National Electrical Code, UL and/or other industry or military standards that are pertinent to the particular end use. Installation or use not in accordance with these codes and standards could be hazardous.



Cooper Lighting Solutions

Usk House, Lakeside, Llantarnam Park,

Cwmbran, NP44 3HD, UK

t: +44 (0)1923 495495 e: info@cooperlighting.co.uk

www.cooperlighting.co.uk

Document: SI-2-D 9850-000693-01