

Source Controllers

Wall mounted dimming & switching
source controllers



Contents

Warning Information	2
Installation	3
Supply	5
Load Connections	10
Network Connections	14
Service Switches and LEDs	16
RS485 Connection	18
DMX Input Connection	21
Alarm Input Connection	22
Troubleshooting	23
CPU PCB Schematic	23



WARNING HAZARDOUS VOLTAGES DISCONNECT FROM SUPPLY BEFORE REMOVING COVERS

NO USER SERVICEABLE PARTS INSIDE
SERVICE BY QUALIFIED PERSONNEL ONLY

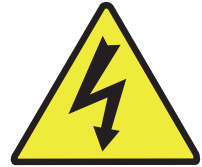

WARNING

- To reduce the risk of fire or electric shock,
DO NOT expose this device to rain or moisture.
DO NOT energise unless the front cover is in place.
- This device must be earthed.
- Installation, programming and maintenance must be carried out by qualified personnel.
Eaton Lighting Systems cannot accept responsibility for repairs or modifications that are not competently executed and in accordance with service or upgrade information.



CE compliant to all relevant standards

IMPORTANT:

**This manual contains operational information and troubleshooting advice. PLEASE
RETAIN THIS MANUAL FOR FUTURE REFERENCE**

The information contained in the product manual is correct at the time of publication, however Cooper Lighting Solutions reserve the right to make changes to the content of this product manual without prior notice. The latest revision of this manual can be downloaded by visiting our website at www.ilight.co.uk

Installation

Location

- Source Controllers must be located in a dry, well ventilated location where the ambient temperature is within the range of +2°C to 40°C (humidity of +5 to +95% non-condensing).
- Source Controllers are designed to be mounted vertically on a stable, horizontal surface. It is important to orientate the unit correctly to allow for effective airflow for ventilation. It is recommended to leave 100mm distance between the Source Controller and walls or other equipment either side of the unit.
- A Source Controller may be connected directly to trunking of depth 50mm or less (see right, top).
- Where trunking depth is greater than 50mm, a gap of 50mm is recommended to allow for adequate airflow for ventilation (see right, bottom).
- Allow adequate space for future maintenance of the unit. Do not install in a location that will later be inaccessible.
- Inductive Source Controllers (SCI type) will emit a low level buzz when dimming loads. This is due to electrical noise suppression components within the unit and may vary with the level of dimming. If noise of this type causes a problem, locate the Source Controller elsewhere.

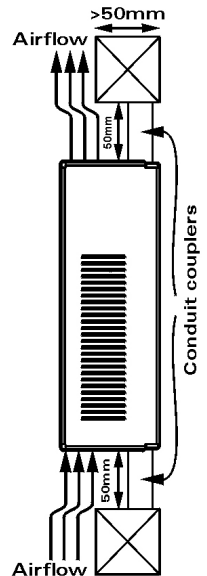
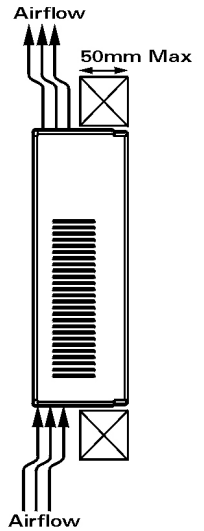
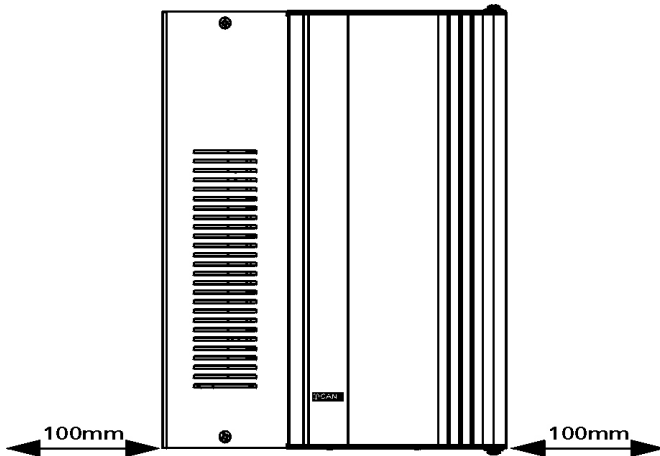

Mounting

Remove the unit cover to gain access to the fixing holes.

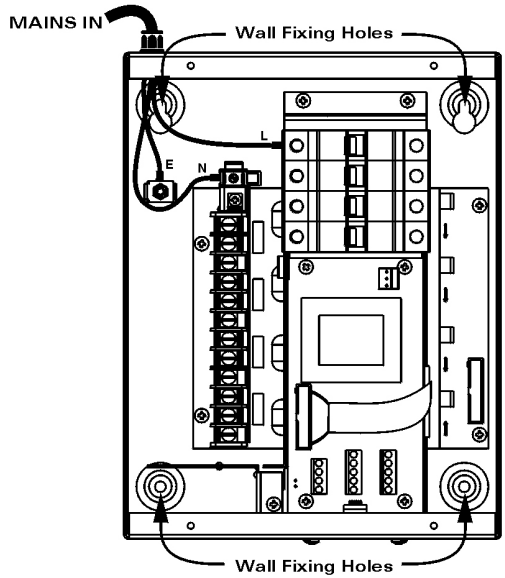
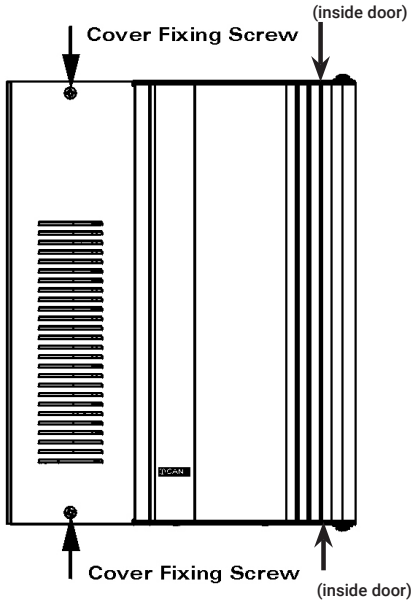

4 Channel version shown (SCI0405S)

Four screws hold on the cover of the Source Controller; two are visible from the front and two are visible only when the MCB cover door is opened. There is no need to remove the MCB door.

Fixing Hole Spacing

Four fixing holes are provided allowing for fixings up to 6mm diameter.

Type	Mounting Hole Spacing	
	MCB	RCBO / RCBOX
SCI0405, SCLED0405, SCH0410, SCS0410/20	220mm(h) x 175mm(w)	275mm(h) x 200mm(w)
-D versions of the above	340mm(h) x 175mm(w)	n/a
SCI0410, SCI0805	340mm(h) x 175mm(w)	375mm(h) x 200mm(w)
SCI1205, SCLED1205, SCH1210/20, SCS1210/20	490mm(h) x 175mm(w)	490mm(w) x 190mm(w)
-D versions of the above	630mm(h) x 175mm(w)	n/a
SCI1210/20	790mm(h) x 175mm(w)	790mm(h) x 225mm(w)

Supply Size

The size of the supply required to a Source Controller must be equivalent to the sum of the loads connect to the unit. Calculate this by assuming that all channels are working at full output simultaneously.

For example:

An SCI1205 Source Controller, with an average load of 3A per channel will have a maximum potential load of $12 \times 3A = 36A$. Therefore a 40A (single-phase) supply will be suitable (see Important Note at bottom of this page).

For a Source Controller being fed from a three-phase supply, **calculate the load per phase**. Do not apply power until you are certain that a good Neutral connection is present at the Source Controller.

Sample supply requirement calculation:

Example - Resistive loads connected to a 4 channel 5A Inductive Source Controller (SCI0405S)

Channel 1 load is 300W
Channel 2 load is 150W
Channel 3 load is 1000W
Channel 4 load is 500W
Total connected load = 1950W

(All loads in this example are resistive or have unity power factor).

For this example the minimum size of the supply required is: $1950W/230V = 8.5A$

Therefore, the unit should be fed with a supply of at least 10A.

For an SCI0405S, the individual load channels are protected by 6A MCBs. A supply capable of delivering more than 10A could be used, but it is recommended that it should not exceed the rating shown on the label fitted inside the door of the unit.

IMPORTANT NOTE

The recommended supply size in Source Controller specifications takes diversity of channel load sizes into consideration. For example, whilst a 12 x 5A Source Controller may have a theoretical maximum load capacity of 60A, loading the unit to 100% capacity is not generally attempted. Some surplus provision is recommended to allow for inrush current when loads are powered on, and avoid circuit protection devices from tripping unnecessarily. A supply of a lesser rating, e.g. 40A, may be stated instead.

Where a channel's maximum load capacity is being reached, it is recommended to move the load to a unit with greater capacity or to split the load across additional outputs to lower the individual load size. **Overloading a Source Controller has the potential to cause damage to the unit, and will not be covered by product warranty.**

Connecting the Supply

Single-phase Source Controllers without Mains Isolators

Relating to model types:

SCI0405(S/N/D), SCI1205D, SCA0410(S/N/D), SCH0410(S/N/D)

- Connect the incoming Live to the left side of the top MCB / RCBO.
- Connect the incoming neutral to the clamp terminal at the top of the neutral bar.
- Connect the earth to the earth stud on the chassis of the unit.

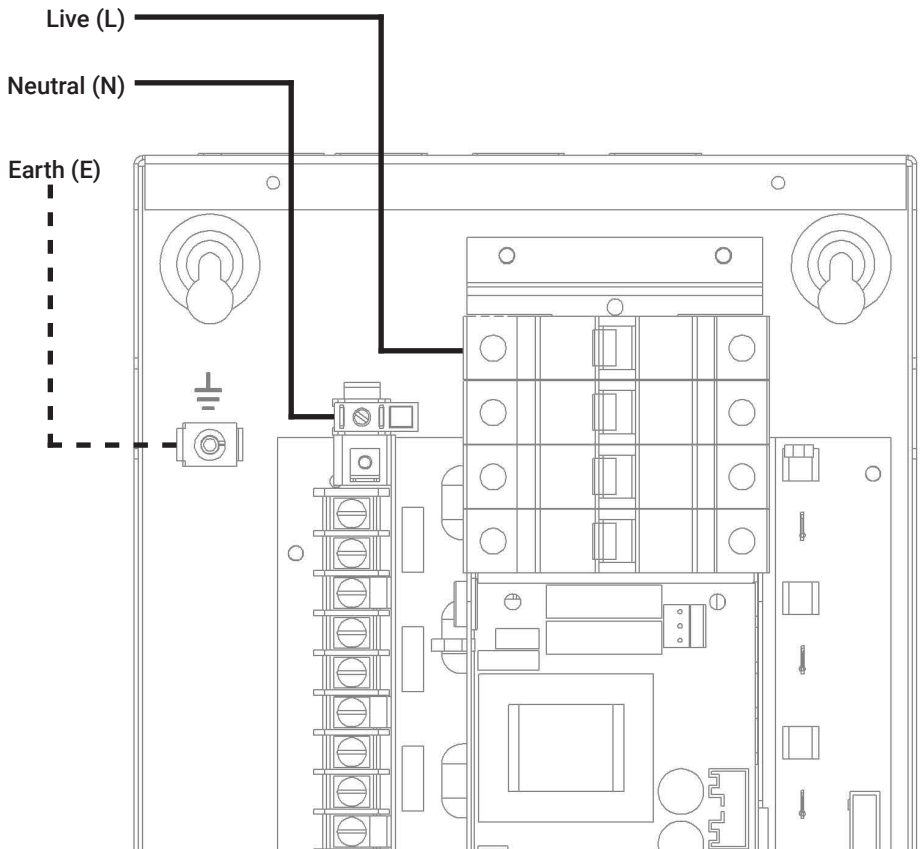

Single-phase Source Controllers with Mains Isolators

Relating to model types:

RCBO & RCBOX versions of all types, SCI1205 (all except D version),

Connect the incoming Live and neutral to the respective terminals on the left side of the isolator at the top of the unit.

Connect the earth to the earth stud on the chassis of the unit.

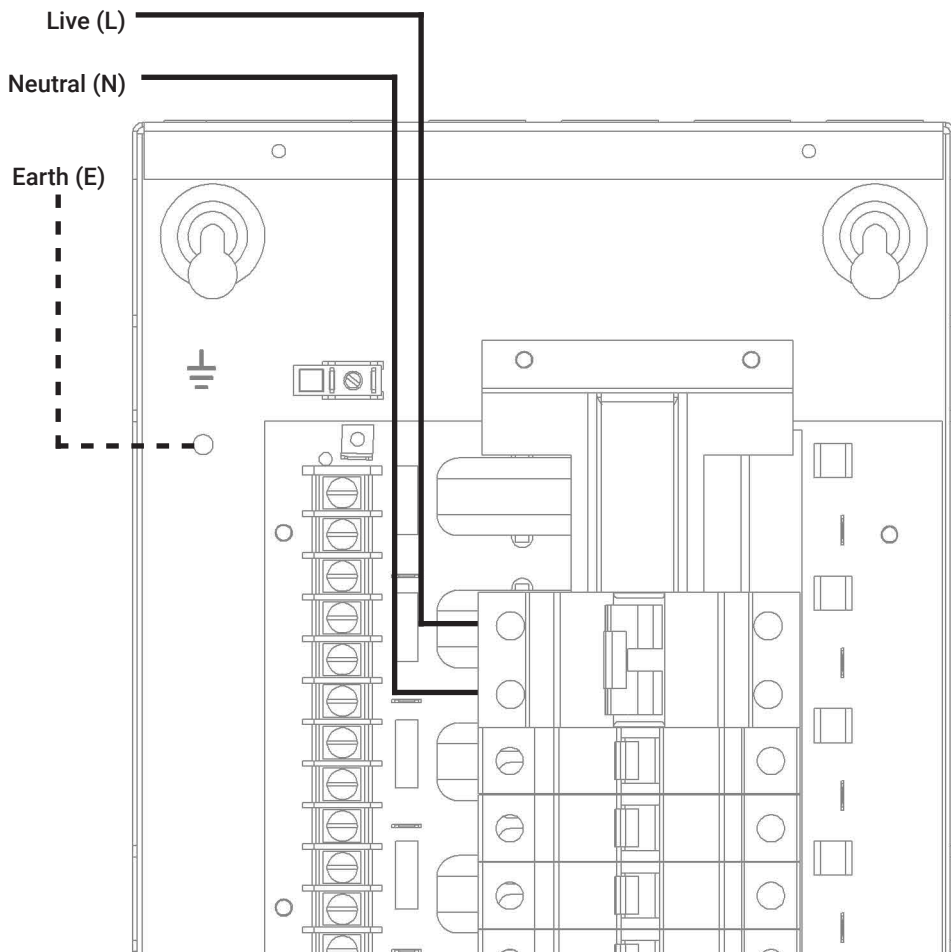

Three-phase Source Controllers with Mains Isolators

Relating to model types:

SCI1210D, SCI1220D, SCA1210 (all types), SCH1210D, SCH1220D, SCS1210D, SCS1220D

Connect the incoming Live phases and neutral to the respective terminals on the left side of the 4-pole isolator at the top of the unit.

Connect the earth to the earth stud on the chassis of the unit.

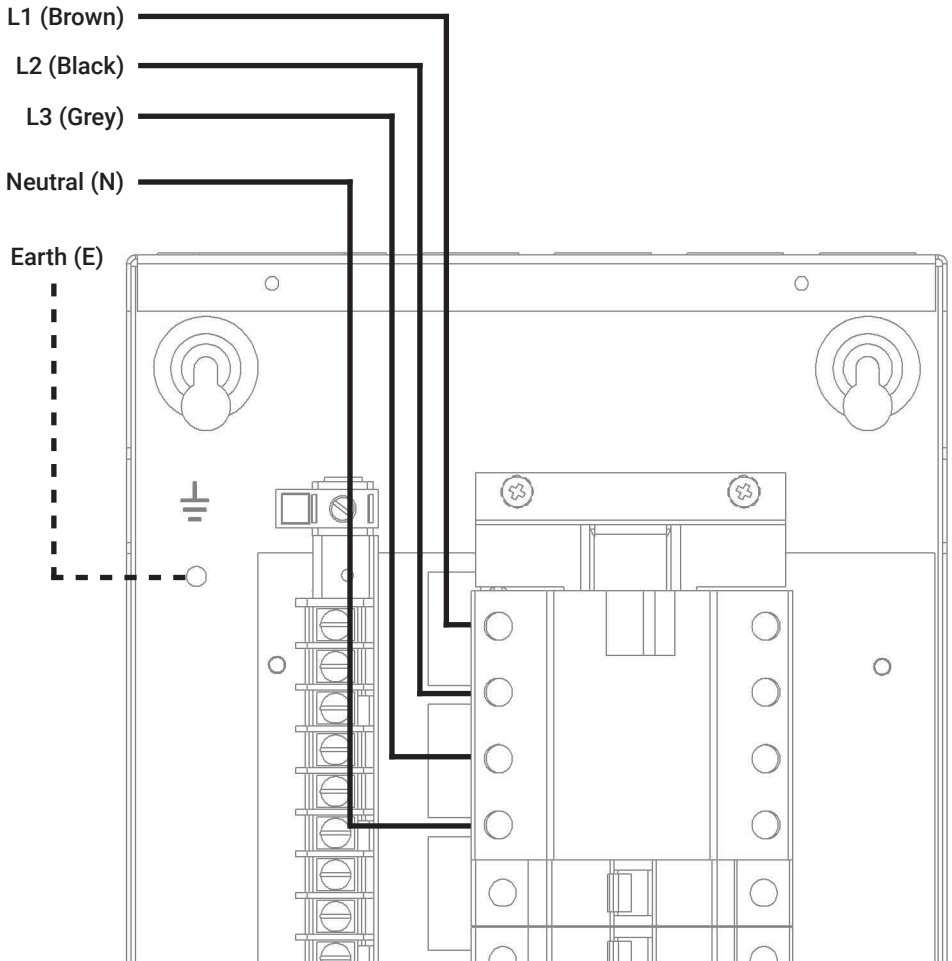

Single-phase Supply for Three-phase Source Controllers

Relating to all three-phase model types.

IMPORTANT: The single-phase supply must be rated for the total load size of the dimmer rather than just the maximum per phase.

This is particularly relevant when connecting 3-circuit track, as the neutral cable is common to all 3 circuits and must therefore be rated for the total load across all three circuits rather than per-phase.

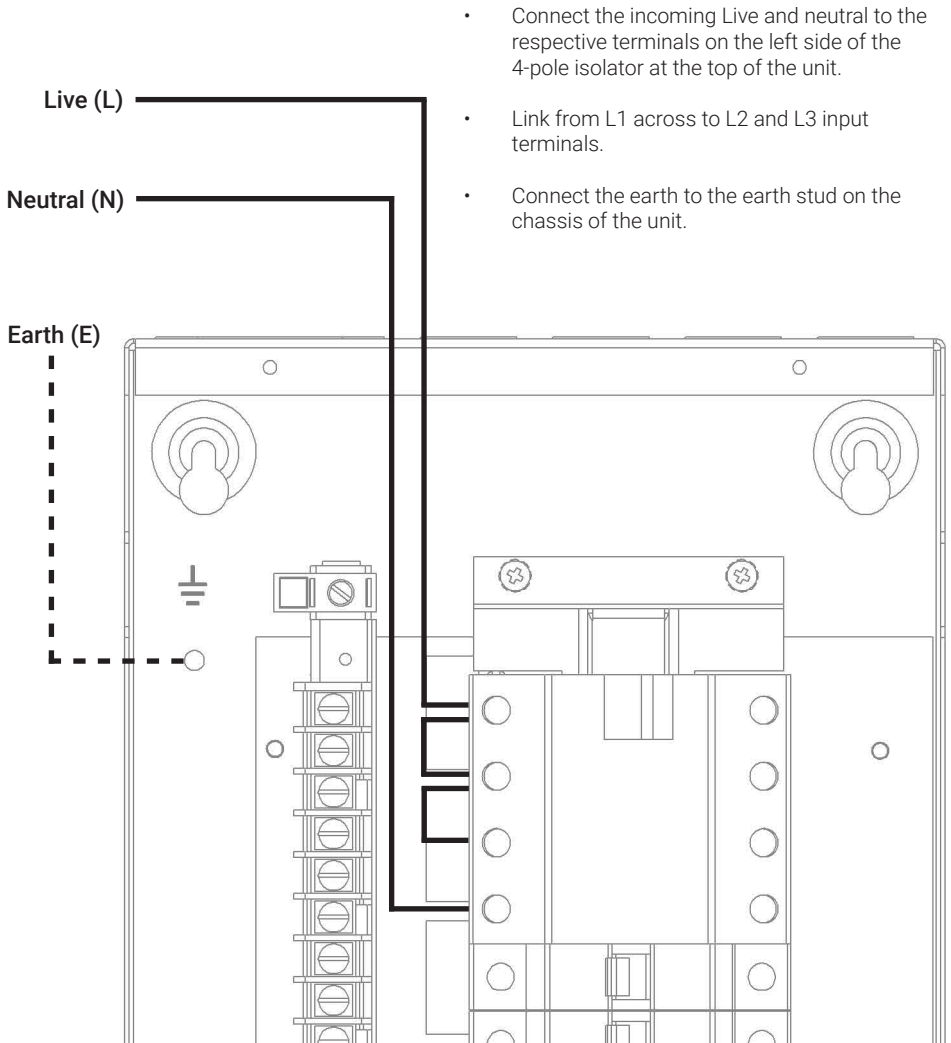

Load Connections

Load Compatibility

It is essential that the correct Source Controller is used according to load type. Consult the table below if you are unsure about load type before connecting the load to the Source Controller.

IMPORTANT: Failure to use the correct Source Controller or load type has the potential to damage the Source Controller, load, or both and is not covered by product warranty.

Model (all versions)	Supply (phases)	Compatible Load Types	Max. Load per Channel (@230V) (~W / A)
SCI0405	SP only	Leading-edge, mains & LV (tungsten, halogen)	1150W / 5A
SCI0410	SP only	Leading-edge, mains & LV (tungsten, halogen)	2300W / 10A
SCI0420	SP only	Leading-edge, mains & LV (tungsten, halogen)	4600W / 20A
SCI1205	SP only	Leading-edge, mains & LV (tungsten, halogen)	1150W / 5A
SCI1210	SP or TP	Leading-edge, mains & LV (tungsten, halogen)	2300W / 10A
SCI1220	SP or TP	Leading-edge, mains & LV (tungsten, halogen)	4600W / 20A
SCA0410	SP only	Leading & Trailing-edge, mains & LV (tungsten, halogen).	2300W / 10A
SCA1210	SP only	Leading & Trailing-edge, mains & LV (tungsten, halogen).	2300W / 10A
SCH0410	SP only	HF ballast; 1-10V, DSI, DALI broadcast.	2300W / 10A
SCH0420	SP only	HF ballast; 1-10V, DSI, DALI broadcast.	4600W / 20A
SCH1210	SP or TP	HF ballast; 1-10V, DSI, DALI broadcast.	2300W / 10A
SCH1220	SP or TP	HF ballast; 1-10V, DSI, DALI broadcast.	4600W / 20A
SCS0410	SP only	Switched only; inc. FL, Metal Halide, LED	2300W / 10A
SCS0420	SP only	Switched only; inc. FL, Metal Halide, LED	4600W / 20A
SCS1210	SP or TP	Switched only; inc. FL, Metal Halide, LED	2300W / 10A
SCS1220	SP or TP	Switched only; inc. FL, Metal Halide, LED	4600W / 20A

Load Mains Output Connections (all models)

Single-phase Operation

The output terminals are ordered by channel number and correspond to the MCBs/RCBOs (Live terminal L4 is monitored by the 4th breaker down).

On RCBO units the neutral is not common (there is no neutral bar running down the terminals) so you must ensure that the correct neutral wires are connected to the neutral terminals.

On units such as the SCI1205, the channel indicator LEDs on the right-side of the dimmer directly correspond to the breaker and output terminal to the left side.

(SCI0405 shown)

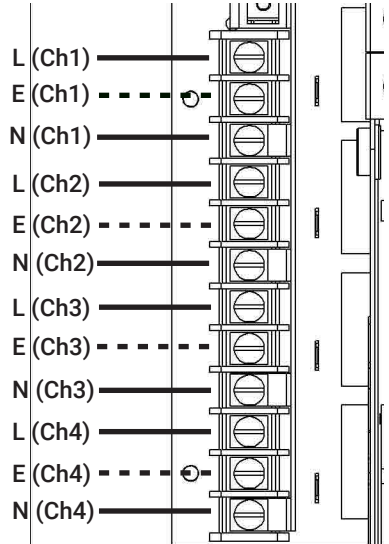

Three-phase Operation

Three-phase units maintain output terminal order according to channel number, rather than grouping the outputs together by phase.

For the SCI1210/20 and SCA1210 models, the output LEDs to the right-hand side of the unit are grouped by phase. This is because each of the three Power PCBs are controlling each of the phases.

Therefore, if the second LED down on the right side of the unit is on, and the circuit needs to be isolated, this corresponds to the second output of phase L1, which is output channel 4 and therefore breaker number 4 on the Source Controller.

(SCA210 shown)

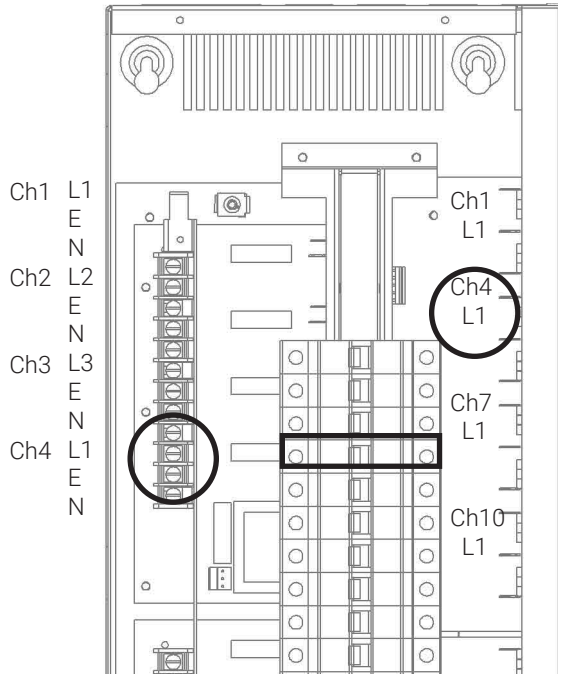

HF Control Cable Specification (SCH- only)

HF ballast control cables must be a mains rated 2-core flex of minimum 1mm core diameter. This applies to all types of HF ballast control , be it 1-10V, DSI or DALI.

HF ballast control cables should not be considered as data cables (as per those used for the iLight network). Network cable such as CAT5/6 should not be used for HF control wiring since it is not mains rated and has limited core diameter.

If there is any doubt concerning which cable carries mains, this must be resolved (using a voltmeter) before connecting to the Source Controller.

HF Control Cable Topology

1-10V Analogue

- The pair of control cables are polarity dependent so you cannot cross them.
- Ballasts must be wired in parallel in a daisy chain arrangement. No spurs or star wiring are permitted.
- Maximum 100 ballasts/drivers per channel.

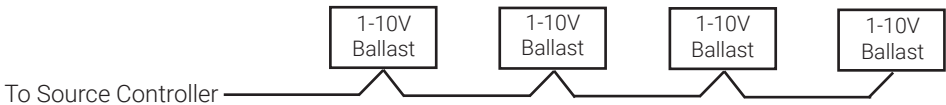

DSI and DALI

- The pair of control cables are not polarity dependent.
- Wiring topology is open, allowing for spurs and star configurations.
- Maximum 32 ballasts/drivers per channel, 128 ballasts/drivers total per Source Controller.

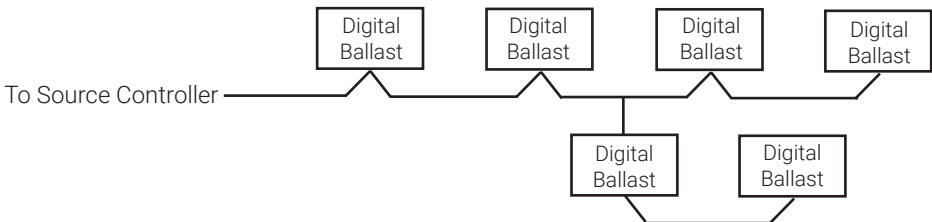

SCH0410 and SCH0420

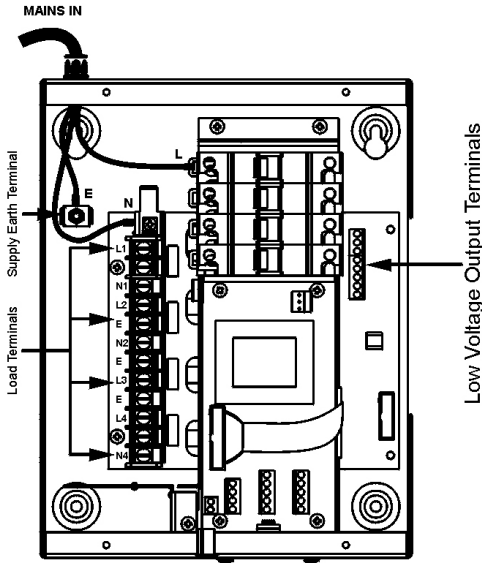

- HF control connections are made to the grey coloured 8-way terminals on the right-hand side of the Source Controller.
- These terminals are labelled 0V, DIM1, 0V, DIM2...
- For each pair of outputs there is a red LED. This will dim in conjunction with the output level when in 1-10V mode, or flash constantly when in DSI or DALI mode.
- Ensure each HF control pair is terminated at the connection corresponding to the associated mains pair - for example all ballasts which are fed with 230Vac from MCB/RCBO #2 must have their low voltage cable terminated at 0V and DIM2.

SCH1210 and SCH1220

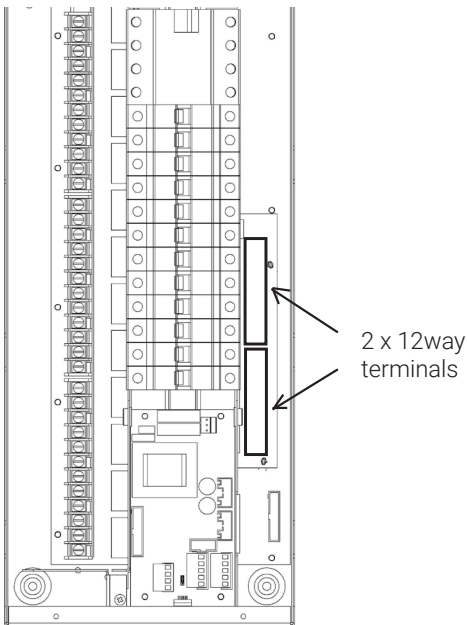

- HF control connections are made to the two green coloured 12-way terminals on the right-hand side of the Source Controller.
- These terminals are labelled 0V, DIM1, 0V, DIM2...
- For each pair of outputs there is a red LED. This will dim in conjunction with the output level when in 1-10V mode, or flash constantly when in DSI or DALI mode.
- Ensure each HF control pair is terminated at the connection corresponding to the associated mains pair as per SCH0410/20 and SCI0805.

Network Connections

Network Cable Specification

The iLight network is the communication backbone of the system allowing input devices (Control Panels, Touchscreens and Interfaces) to send commands to output devices (Source Controllers).

iLight recommend using a Belden 1502R/1502P data cable.

Maximum length of cable run for the iLight Network is **500m**. This can be extended with a BN2 Network Bridge/Repeater. Details of this item are on the iLight website (www.ilight.co.uk)

Network Cable Topology

The iLight Network is of CAN bus (Controller Area Network) standard. A maximum of 100 devices can be added to the network on a single run.

NOTE: Device quantity can be increased with a BN2 Network Bridge/Repeater unit.

The network must be wired in a 'daisy-chain' radial configuration, resulting in two end-of-line positions for the CAN pair. Star wiring and spurs are not permitted without the addition of a Starbox or BN2 Network Bridge/Repeater. Details of these products are on the iLight website.

The order that devices are situated on the network is not specific, but 12Vdc power must be evenly distributed across the network for powering Control Panels, Interfaces and other input devices.

Simple Network Example

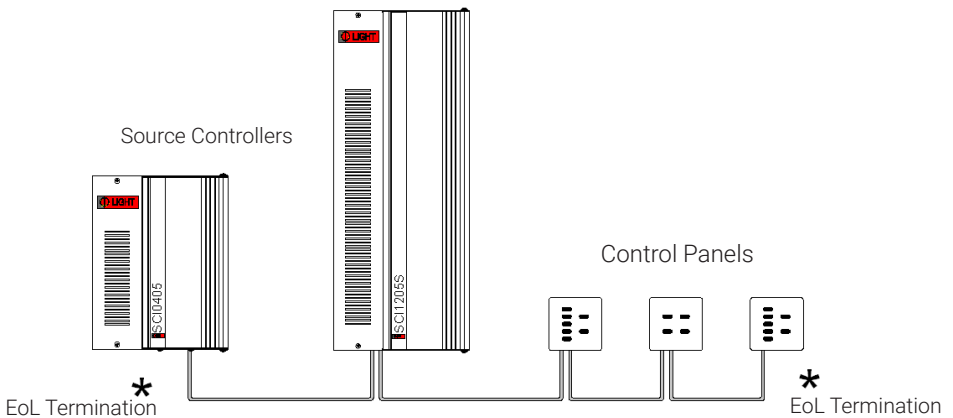

Connection to the network

Connections for the iLight network are located on the CPU card at the bottom of the unit with the cover removed. iLight recommend Belden 1502P or 1502R data cable.

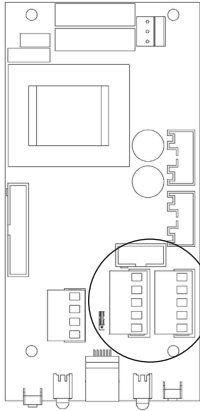

There are two 5-way green connectors for the network. Either of these may be used (as an in and an out) or a single used with the network cable doubled-up to it.

Please observe the standard wiring colour codes as follows:

Function	Network Cable Colours
0V	Black
CAN L	White
Shield	Silver
CAN H	Blue
+12Vdc	Red

IMPORTANT NOTE: Connecting a mains potential cable to the iLight Network terminals is likely to damage the unit and others connected, and invalidate warranty.

Network Termination

Applies 120ohm resistor to the iLight network.
Required at each end of the network cable run only.

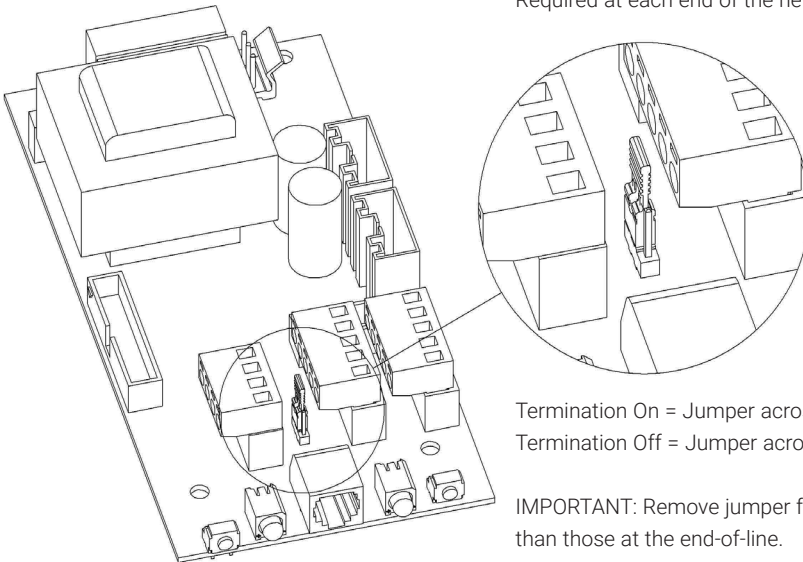

Termination On = Jumper across lower pins
Termination Off = Jumper across upper pins

IMPORTANT: Remove jumper for all devices other than those at the end-of-line.

Service Switches and LEDs

These switches and LEDs are located at the base of the unit.

The two service switches on the source controllers are used for the following:

- Entering Diagnostic Mode.
- Putting the Source Controller in override mode.
- Sending a message to identify the device on the network.
- Sending a message to identify the device on the network.

NORMAL RUNNING MODE

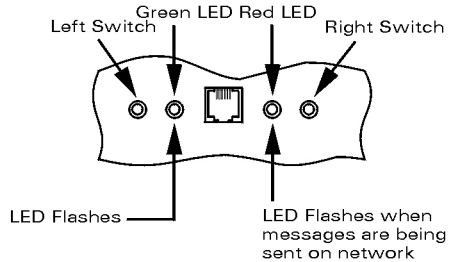

The LEDs indicate the following:

- Normal operation:
Steady green LED blinking 1 x per second.
Red LED off.
- Message transmission and receipt indicated by red LED flashing for duration of data transmission.
- Override status: Both LEDs flashing together or just red flashing and green off.

DEVICE IDENTIFICATION

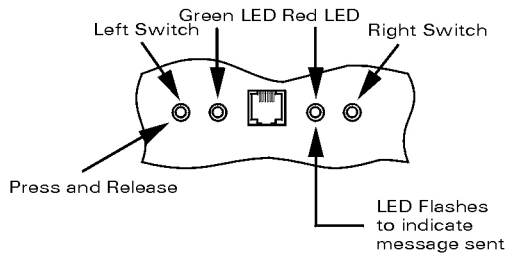

ICANnet Fault

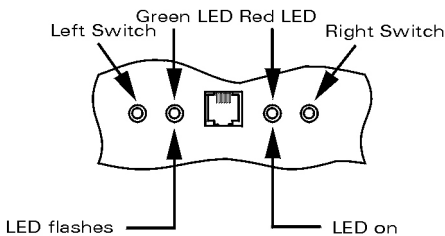

ICANnet error status will occur when a Source Controller is not connected to an iCAN network for any reason. Once either connected to a network of one or more other devices which are powered the error status will be removed. It is still possible to enter Diagnostic mode if a Source Controller is in iCANnet error status.

ENTERING DIAGNOSTIC MODE

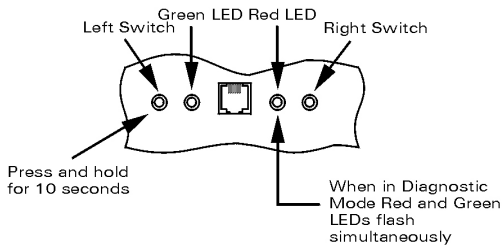

Override Mode

Placing the unit into override mode allows for testing of the Source Controller outputs regardless of how the unit is currently programmed. This is useful for testing power to circuits prior to the system being commissioned or for fault finding where it can be used to test if there is an issue with the Source Controller output(s) should this be suspected.

When the Source Controller is placed into override mode it will no longer respond to commands sent over the iLight network.

Override mode can also be used to restore power to outputs if control is lost or temporarily removed to allow lighting to remain on until control is restored. NOTE: Override mode only affects the outputs on the Source Controller on which it is activated.

To exit diagnostic / override status follow the steps shown. If power is cycled to the Source Controller then this will also take the unit out of override mode and it will start up in the default running status.

VERRIDE MODES

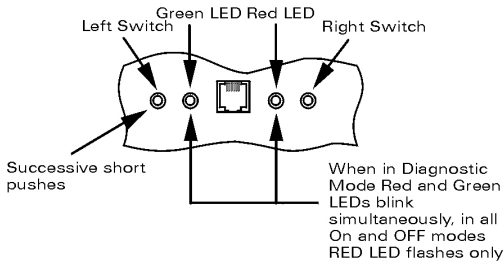

SEQUENTIAL TEST MODE

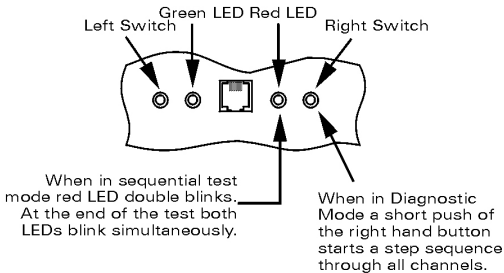

EXITING DIAGNOSTIC MODE

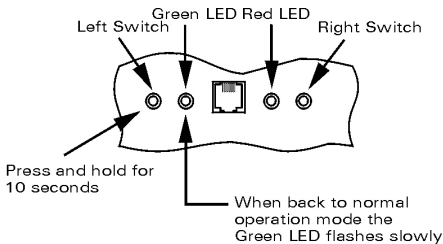

RS485 Connection

Source Controllers have an RS485 port located on the CPU PCB which allows for direct serial integration with the iLight network. If multiple Source Controllers are linked on the iLight network then only a single RS485 connection is required in order to potentially control all devices.

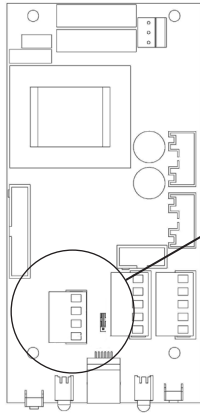

Function
Alarm (N/A)
0V
RS485+
RS485-

Use CAT5 FTP or equivalent data cable for the RS485 connection.

The pin marked Alarm should be ignored. This feature is covered in the Alarm Input section.

This port can also be adapted to be used as a DMX input port for DMX control of the Source Controller's outputs. It cannot be used for this purpose if it is already being used as an RS485 port. This feature is covered in the 'Output Control by DMX Input' section.

IMPORTANT NOTE: Connecting a mains potential cable to the RS485/DMX terminals is likely to damage the unit and others connected, and invalidate warranty.

RS485 Data Format

- Baud Rate: 9600
- 8 Data Bits
- 1 Stop Bit
- No Parity

RS485 Message Format

Please refer to the RS485 Serial Integration article on the iLight Technical Support site for a full glossary of available RS485 messages.

Sequence Control Commands and RS485

To send sequence commands over an RS485 connection an Extended ASCII PCB needs to be present on the CPU board of the Source Controller hosting the RS485 connection. This is a small, plug-in PCB that will enable these longer ASCII sequence commands to be sent and received. You must ensure that the Source Controller is powered down when fitting the board and then restarted with the board in position, or it will not be recognised by the unit.

The Extended ASCII PCB is must be plugged into the 10-pin plug on the CPU board as shown on the right.

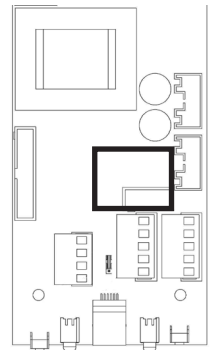

RS485 Message Glossary

Virtual control messages are used to control the system, and not individual devices. The message is transmitted across the iLight CAN network to all other devices.

@SSxx:Axx:Fxx<cr> This message selects a scene in an area.
SSxx defines the scene number, where xx is valid from 00 to 99. Scene 00 is OFF.
Axx defines the Area Number, valid for 01 to 99.
Fxx defines the Fade Time, valid for 00 to 99 seconds.

@SAxx:Axx<cr> This message saves the current levels to a scene in an area.
SAxx defines the scene number, valid from 00 to 99. Scene 00 saves to the current scene.
Axx defines the Area Number, valid for 01 to 99.

@RSxx<cr> This message requests the current scene number in an area.
RSxx defines the Area Number, valid for 01 to 99.

@RExx:Axx<cr> This message reports the current scene number in an area.
RExx defines the Scene Number, valid for 00 to 99. Scene 00 is OFF.
Axx defines the Area Number, valid for 01 to 99.

@SCxx:Axx:Lxx:Fxx<cr> This message sets the level of a channel in an area.
SCxx defines the channel number, valid from 00 to 99. 00 affects ALL Channels in an Area.
Axx defines the Area Number, valid for 01 to 99.
Lxx defines the Level, valid for 00 (0%) to FF (100%).
Fxx defines the Fade Time, valid for 00 to 99 for seconds.

@RCxx:Axx<cr> This message requests the level of a channel in an area.
RCxx defines the channel number, valid from 00 to 99. 00 requests ALL Channels in an Area.
Axx defines the Area Number, valid for 01 to 99.

@RLxx:Axx:Lxx<cr> This message reports the current level of a channel in an area.
RLxx defines the Channel Number, valid for 01 to 99.
Axx defines the Area Number, valid for 01 to 99.
Lxx defines the Level, valid for 00 (0%) to FF (100%).

@CRxx:Axx <cr> This message increments the area by 1% level.
CRxx defines the channel number, valid from 00 to 99. 00 affects ALL Channels in an Area.
Axx defines the Area Number, valid for 01 to 99.

@CLxx:Axx <cr> This message decrements the area by 1% level.
CLxx defines the channel number, valid from 00 to 99. 00 affects ALL Channels in an Area.
Axx defines the Area Number, valid for 01 to 99.

@SFxx:Axx <cr> This message stops fading in an area.
SFxx defines the channel number, valid from 00 to 99. 00 affects ALL Channels in an Area.
Axx defines the Area Number, valid for 01 to 99.

RS485 Sequence Messages

IMPORTANT: In cases where it is necessary to control sequences over an RS485 connection, an Extended ASCII board needs to be present on the CPU board of the dimmer(s) hosting the RS485 connection(s). This is a small, plug-in PCB that will enable these longer ASCII sequence commands to be sent and received. There is no programming required, although you must ensure that the unit is powered down when fitting the board and then restarted with the board in position, or it will not be recognised by the dimmer unit.

Command QS (Start Sequence)

This message initiates a selected sequence. The syntax is: @QSxx:Sxxx:Nxxx:Axxx<cr>

QSxx defines the sequence number.

Sxxx defines the segment number where xxx is 001 to 253.

Nxxx defines the node number where xxx is 001 to 253.

Axxx defines the action (step) number. 000 will resume a sequence from a Pause.

Command QP (Pause Sequence)

This message pauses a selected sequence. The syntax is: @QPxx:Sxxx:Nxxx<cr>

QPxx defines the sequence number.

Sxxx defines the segment number where xxx is 001 to 253.

Nxxx defines the node number where xxx is 001 to 253.

Command QT (Stop Sequence)

This message halts a selected sequence. The syntax is: @QTxx:Sxxx:Nxxx<cr>

QTxx defines the sequence number.

Sxxx defines the segment number where xxx is 001 to 253.

Nxxx defines the node number where xxx is 001 to 253.

DMX Input Connection

Source Controllers have an RS485 port located on the CPU PCB which allows for direct serial integration with the iLight network. This port can be converted into an input connection for DMX control of the Source Controller by a lighting desk, for example. **To enable DMX control a DI-1 DMX Input PCB must be fitted to the Source Controller.**

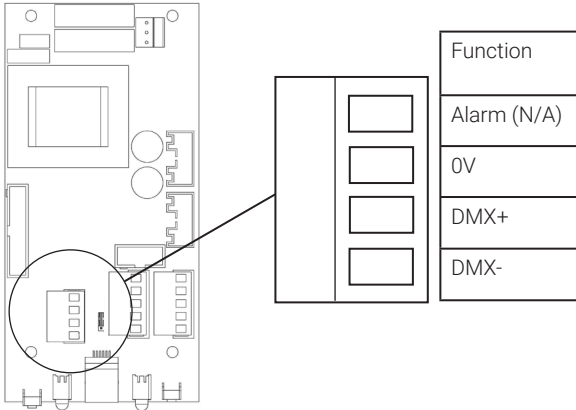

Use CAT5 FTP or equivalent data cable for the DMX connection.

The pin marked Alarm should be ignored. This feature is covered in the Alarm Input section.

The port cannot be used for DMX input if it is already being used as an RS485 port.

DMX input is per Source Controller, meaning that this conversion and connection must be made to all Source Controllers that are required to be controlled via DMX input.

- A maximum of 32 devices can occupy a single DMX segment (including the Source Controller) with a total cable length of 300m.
- DMX must be terminated at the end-of-line with a 120ohm value resistor, as per the CAN network.
- Source Controllers will act like a DMX device and DMX addressed must be assigned to each output of the Source Controller. By default this is 1-4 or 1-12.
- The DMX address is assigned to each output through iLight programming software, and each output can be assigned a value between 1 and 512. Any outputs assigned to the same DMX address will therefore respond as a group.

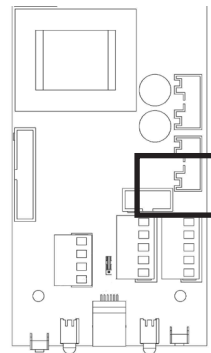

(Above) The DI-1 DMX Input card plugs into the 10-pin socket on the CPU card. The Source Controller's power must be reset after installation in order for it to recognise the PCB.

For more information on DMX control and wiring topology, please consult the 'Introduction to DMX' article available on the iLight Technical Support website.

Alarm Input Connection

Source Controllers have an Alarm Input located on the CPU PCB which allows for direct connection of a volt-free contact closure input from a fire or security system.

When a contact closure occurs across the normally-open Alarm and 0V terminal on the Source Controller, an alarm scene is triggered which is broadcast across the iLight Network to all other devices.

The default scene setting is all channels to 100%. Control Panels are also configured by default to be locked when the alarm link is in place to disable manual override of the lighting during an alarm.

Upon release, channels will return to the last selected scene levels and Control Panels will be re-enabled.

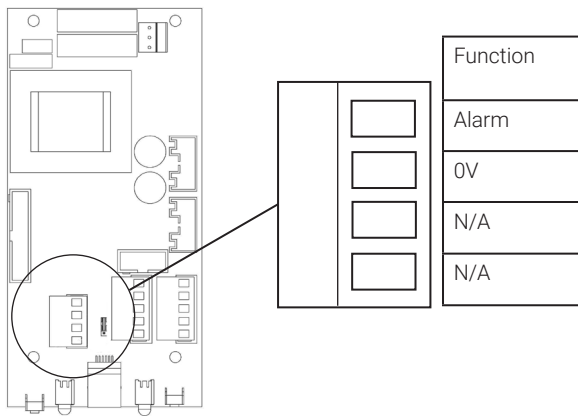

The Alarm Scene can be reconfigured when the Source Controller is programmed and it is possible to set other devices on the network to ignore the alarm status if control must be maintained to some outputs or Areas.

NOTE: The Alarm connection cannot be adapted for use as a volt-free inputs for other purposes, such as sensors. UIG2 Universal Interfaces, UIM Mini Universal Interfaces and UIS Sensor Interfaces are required for additional input requirements to the iLight Network.

Troubleshooting

The loads are not switching on when I first power up the Source Controller.

Check for voltage on the output terminals to ensure that this is not a wiring issue to the load(s). Make sure that the green CPU card status LED is blinking slowly (1x per sec).

If you have already connected up the networked Control Panels or Touchscreens to the unit then try selecting the factory scenes from these.

You can override the unit to get the lighting on to 100%. Please refer to the Override Mode instructions on page 17.

There are one or more outputs stuck on and cannot be turned off.

If all other outputs on the same Source Controller can be controlled successfully from input devices then it is not a network error. A failed triac in the output circuit of an SCL Inductive dimmer will fail to 100% power and will require repair or replacement of the PCB.

On SCH and SCS type units the output may be permanently on because of a sticky relay. Try sharply but carefully tapping the relay module next to that output terminal to see if it releases. This may reoccur if the relay has become worn.

The Source Controller has power but none of the outputs can be controlled from Control Panels or touchscreens.

Make sure that the green CPU card status LED is blinking slowly (1x per sec). Check to see if the red LED to the right of this flashes when operating the lights. You may need to test your network cable in case there is a break or a broken connection somewhere.

Check that the black ribbon cable is fully inserted into the 26 pin socket.

If no LEDs are lit on the CPU card of the Source Controller, but power is present, this suggests that the CPU board or its transformer has a fault and may need replacing or repairing.

I am using iCANsoft and cannot find the Source Controller when searching for devices.

Please see above suggestions. Also, press the button to the left of the green LED on the CPU board to ping the Source Controller. This should make it appear in the search window and display a message in the iLight network monitor window.

If your issue is not covered by any of the above please contact iLight Technical Support. The email address and telephone number can be found on the back page of this manual.

CPU PCB Schematic

This is the single-phase CPU PCB EM6774 found in the majority of Source Controllers, with the exception being the SCI1210/20 models which have a three-phase version. That version is fundamentally the same but has 3 transformers, one per phase, to provide a zero-crossing point for the outputs of each phase.

EM6774 (Series 7 - Green Plug) Source Controller CPU Board Layout

SCI0405, SCI0410, SCI1205, SCT0405, SCT1205,
SCH0410, SCH1210, SCA0410, SCA1210, SCI0805,
SCS0410, SCS1210

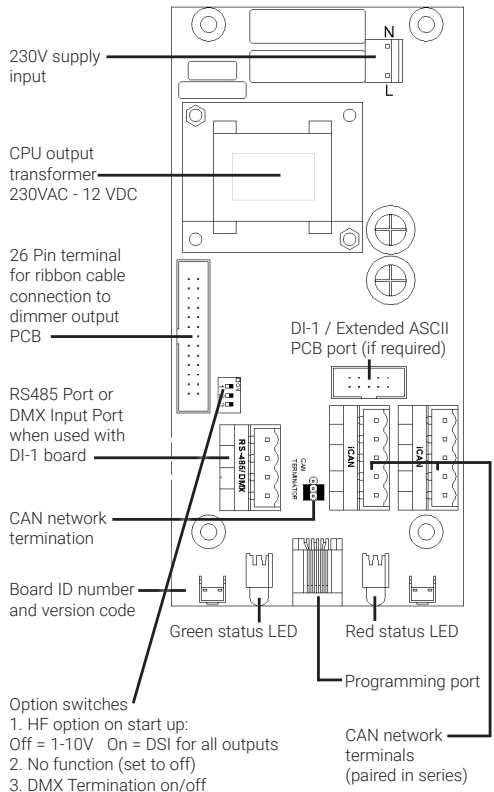

iLight Technical Support

Tel: +44 (0)844 324 9100 (available Mon-Fri 9am-5pm GMT)

Email: ctechsupport@cooperlighting.com

Web: www.iLight.co.uk

All products manufactured by Cooper Lighting Solutions and identified with the iLight product series mark are warranted to be free from defects in material and workmanship and shall conform to and perform in accordance with Seller's written specifications. For detailed warranty information, contact Cooper Lighting Solutions.

This warranty will be limited to the repair or replacement, at Seller's discretion, of any such goods found to be defective, upon their authorized return to Seller. This limited warranty does not apply if the goods have been damaged by accident, abuse, misuse, modification or misapplication, by damage during shipment or by improper service.

There are no warranties, which extend beyond the hereinabove-limited warranty, INCLUDING, BUT NOT LIMITED TO, THE IMPLIED WARRANTY OF MERCHANTABILITY AND THE IMPLIED WARRANTY OF FITNESS.

No employee, agent, dealer, or other person is authorised to give any warranties on behalf of the Seller or to assume for the Seller any other liability in connection with any of its goods except in writing and signed by the Seller. The Seller makes no representation that the goods comply with any present or future federal, state or local regulation or ordinance. Compliance is the Buyer's responsibility.

The use of the Seller's goods should be in accordance with the provision of the National Electrical Code, UL and/or other industry or military standards that are pertinent to the particular end use. Installation or use not in accordance with these codes and standards could be hazardous.



Cooper Lighting Solutions

Usk House, Lakeside, Llantarnam Park,

Cwmbran, NP44 3HD, UK

t: +44 (0)1923 495495 e: info@cooperlighting.co.uk

www.cooperlighting.co.uk